

MONI-K

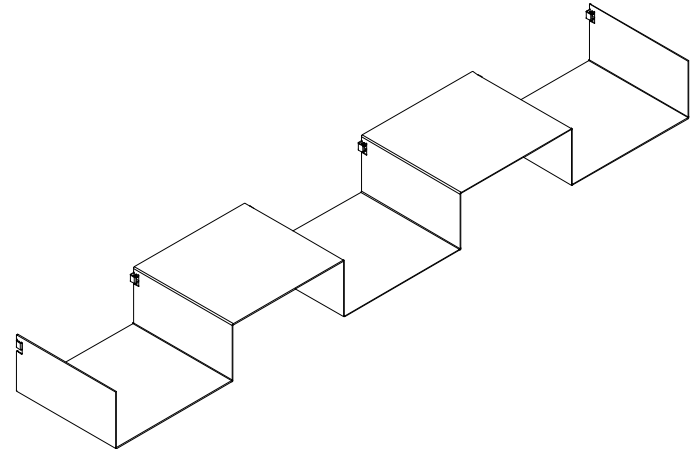

Product Details

Material: 2mm steel plate

Dimensions: 145 x 25 x 12.5 cm.

Finishes: Varnished / Dark grey coat

Weight (per unit): 8.60 kg-18.95 lb

Weight limits: 110kg-242.50 lb

Warning

Read each step carefully before beginning assembly.

This instruction booklet contains important SAFETY information.

Verify the flatness of the wall along the entire length on which you plan to place shelves MONI-K.

The wall anchors included can be adapted to different types of walls to support the weight indicated. If your wall consists of drywall, the weight supported by the wall anchors equal to 22 lbs. We recommend the use of metal umbrella wall anchors to withstand greater loads.

For more information access www.objects.es

Maintenance instructions

Wipe the surface with a soft dry cloth.

Do NOT use any cleaner containing acids, ammonia or abrasives.

components

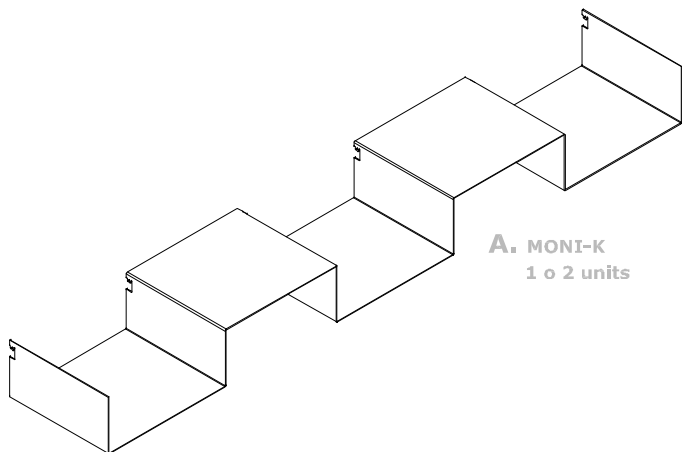

A. MONI-K
1 o 2 units

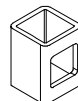

B. Simple support
6 units/MONI-K



C. Black screw
6 units/MONI-K



D. Fischer plastic wall plug
6 units/MONI-K



E. ALLEN key 3
1 unit

instructions

1 Find your design

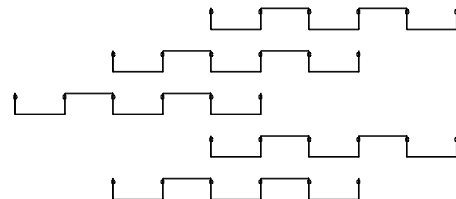
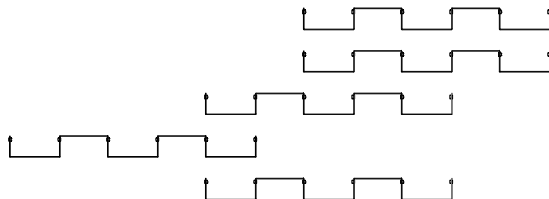
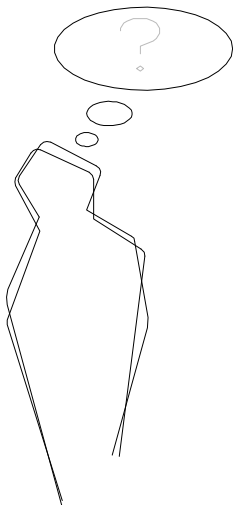

2 Mark fixing points

template for wall mount
available at www.objects.es

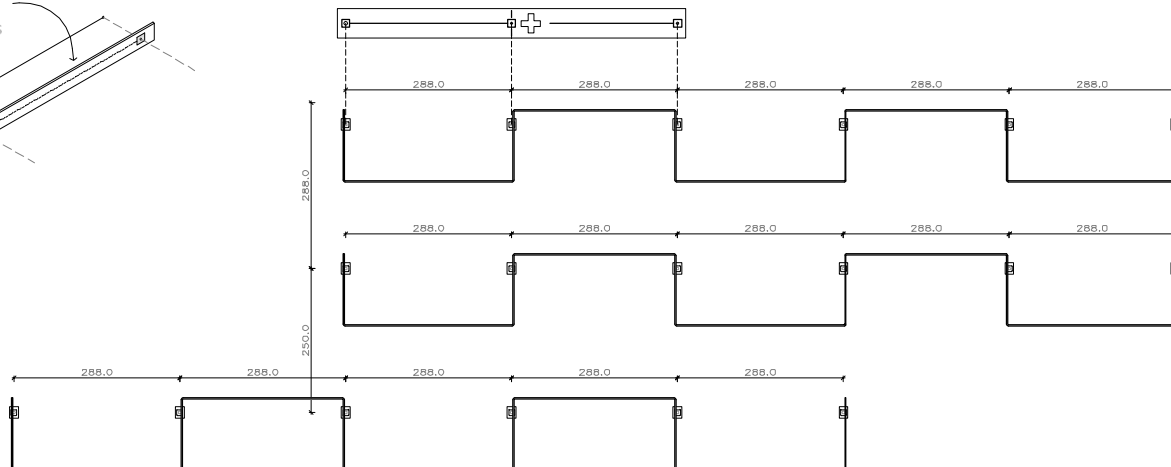
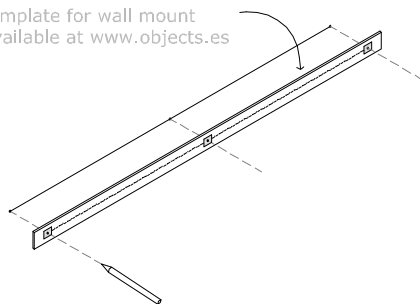

- IMPORTANT: Verify the flatness of the wall along the entire length on which you plan to place shelves MONI-K for correct mounting

- We recommend a separation of 250mm between each element, to facilitate the support of books in the intermediate position.

3 Fix wall supports

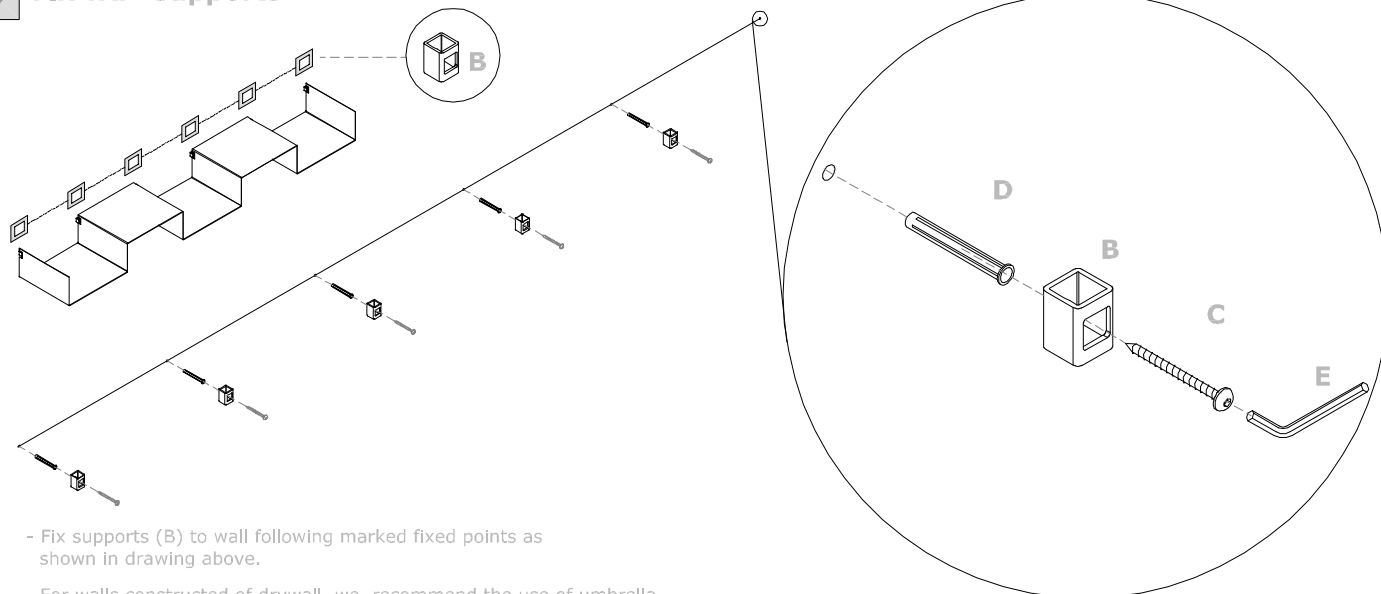

- Fix supports (B) to wall following marked fixed points as shown in drawing above.

- For walls constructed of drywall, we recommend the use of umbrella wall anchor kits. Consult www.objects.es

4 Align shelf MONI-K with supports

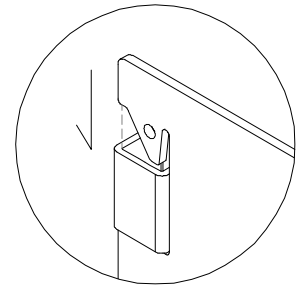
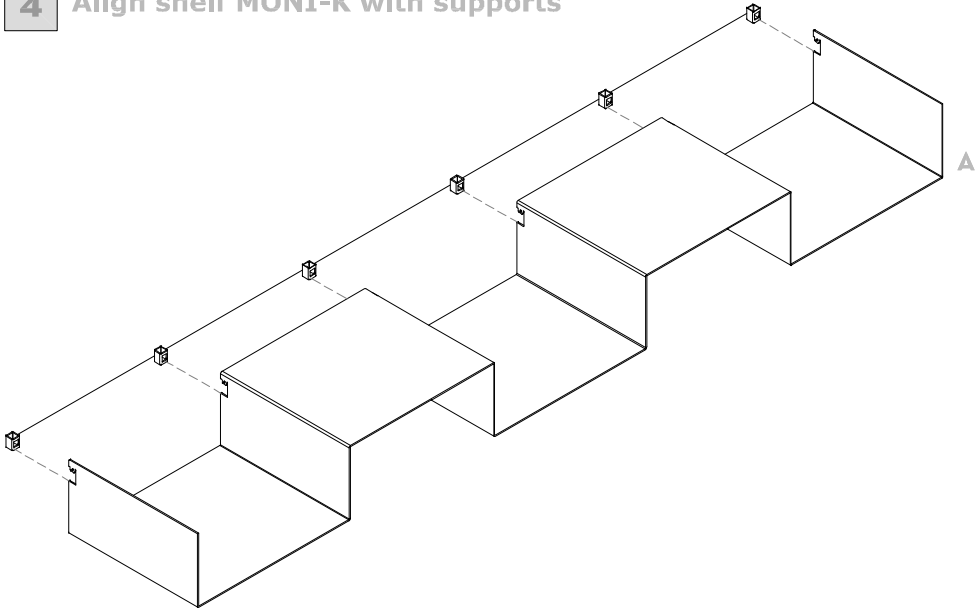

- Fit flanges into supports

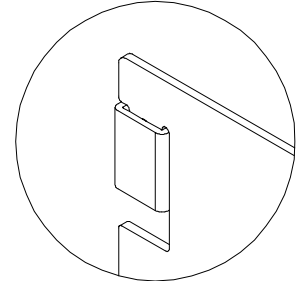

- Press down firmly to secure shelf to supports

5 Mounted shelf

